

Luxuria

MiniTreasure

The personal Luxury safe



KAVAL[®]
SECURITY SYSTEMS & EQUIPMENT COMPANY



A LUXURY SAFE FOR YOUR PRECIOUS COLLECTIONS

Minitreasure is a Tested and Certified Luxury safe which offers Protection Against Fire and Burglary

KEY FEATURES

- Dual Protection: Tested and Certified for both burglary and fire resistance.
- Burglary Protection: ECB.S certified to EN 14450 - S2.
- DFire Protection: ECB.S certified to EN 15659 for 30 minutes.
- Safe can be anchored to the floor.

CHOICE OF LOCKING OPTIONS

- EN 1300 certified double-bitted Key Lock (Class A) or Electronic Lock (Class B)

Electronic Lock Features:

- Easily programable by the user.
- Battery can be replaced from outside.
- 1 master code & 1 user code.
- Time delay: Up to 99 minutes before door unlocks.

CONSTRUCTION

- Outer and inner steel layers with a specially formulated burglary & fire-resistant core.
- High-performance material ensures lightweight.
- Due to lightweight this can be installed anywhere.

CUSTOMIZATION

- The safes can be painted with any colours.
- The safes can be covered with Genuine or Artificial Leather with any colours.
- The drawers can be made with any Wood or covered with Genuine Leather/ Artificial Leather/ Microfibre.
- The Interior of the drawers can be made with Linen, Alacantara or Suede.
- Different types of handles can be provided.
- Push to open, pull to open, removable drawers can be provided.



Jewellery Safes



- Tested and Certified Jewellery Safes with Specially designed drawers for Jewellery, Watches and Precious items.
- All interior areas of the safes can be customized.
- Facility to hang long chains on the backside of the door.



Gun Safes



Secure your rifles,
precious jewels, and valuable
watches, all in a secure space of
unmatched skill. Where fortification
harmonizes with sophisticated living.





A timeless, secure safe designed to protect your watch collection.



HEISSE & SÖHNE

SEIT 1976

MADE IN GERMANY

CUSTOMIZED
**WATCH
SAFES**

WITH PREMIUM WATCH
WINDERS AND STORAGE
FACILITY

Luxury Hand-Crafted Leather Safes

Transform your premium safe into a masterpiece of elegance with our custom leather wrapping. Each piece, expertly handcrafted, blends traditional artistry with modern flair. The meticulously selected leather enhances the safe's beauty, while its rich texture and flawless finish add a touch of distinction. Beyond mere security, your safe becomes a striking display of style and grandeur. Our leather-clad safes, designed for those who value exquisite details, perfectly unite security with opulent design.



DRAWER OPTIONS

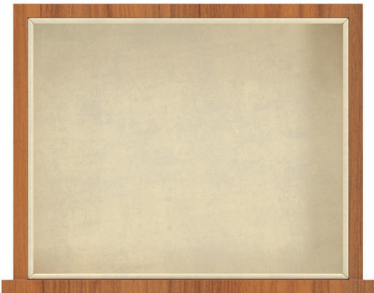

D1 - PLAIN DRAWER

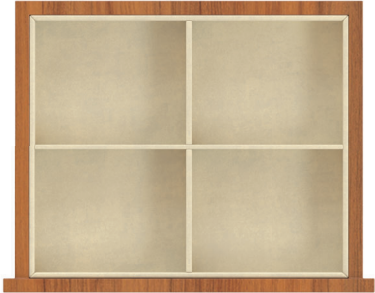

D2 - 4 PARTITIONS



D3 - LONG CHAINS



D4 - SMALL PARTITIONS



D5 - WATCHES



D6 - WATCHES



D7 - BRACELETS



D8 - NECKLACE SET



D9 - 2 NECKLACES



D10 - RINGS AND EARRINGS

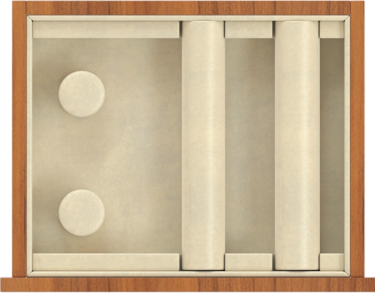

D11 - BANGLES

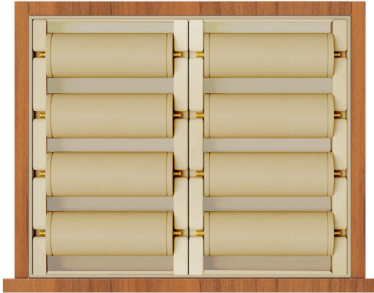

D12 - BANGLES

WOOD FINISHES FOR DRAWERS



WR1
Rosewood



WE2
Ebony



WO3
Oak

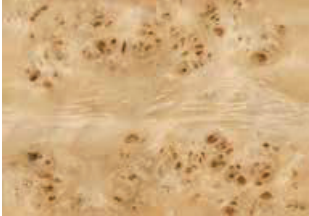

WB4
Burl Eye



WL5
Walnut



WWO6
White Oak

DRAWER INTERIORS



VW001
Off-white

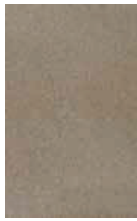

VC001
Cream



VC002
Brown



VW003
Light Blue



VB014
Dark Blue



VR005
Red

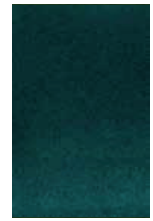

VG007
Green

LEATHER FINISHES FOR CLADDING



LY003
Golden Brown Leather

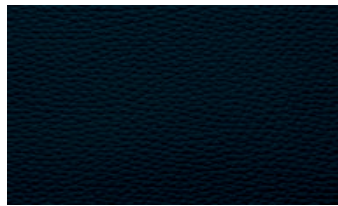

LK001
Black Leather



LB001
Light Taupe Leather



LR001
Red Leather



LG002
Dark Green Leather



LO002
Orange Leather



LU001
Blue Leather

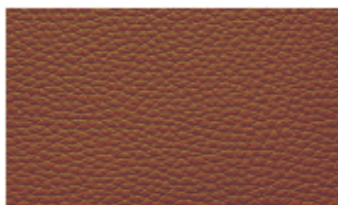

LB001
Brown Leather



LT001
Tan Leather

STITCH COLOURS FOR LEATHER

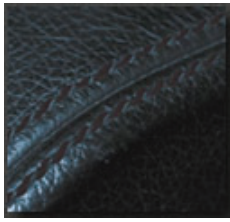

SBI
Black

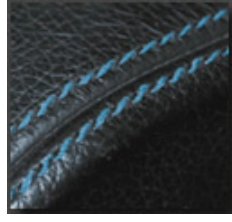

SL2
Light blue

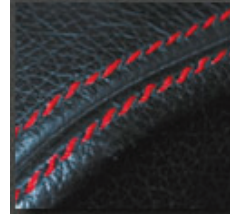

SR3
Red

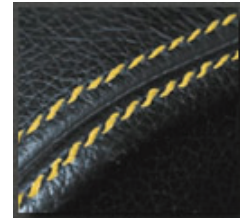

SY4
Yellow



SG5
Grey

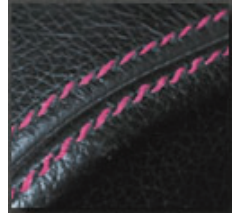

SP6
Pink



SO7
Orange



SG8
Green

POSSIBLE COLOURS FOR SAFES



CNB1
Royal Blue



CR2
Red



CG3
Green



CY4
Grey

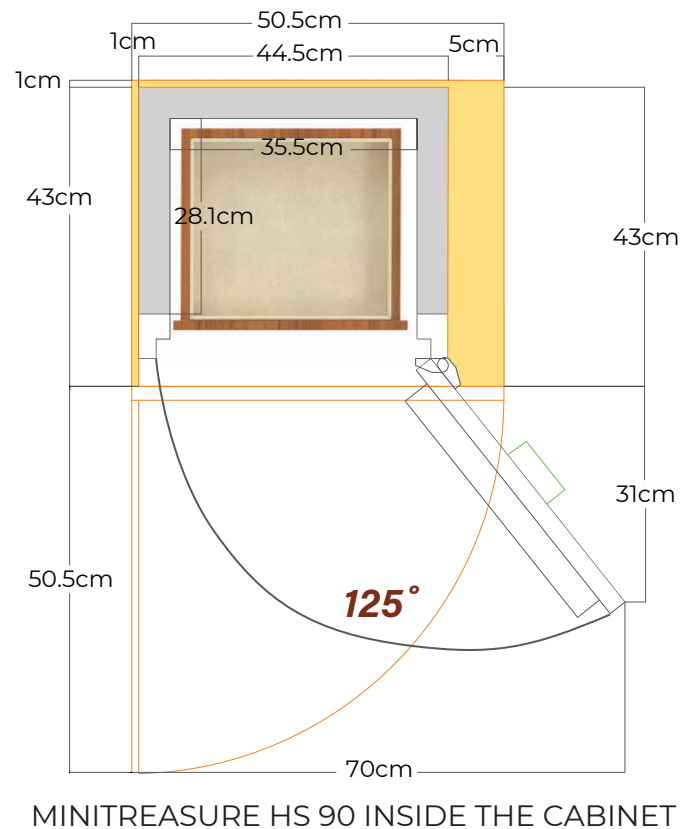
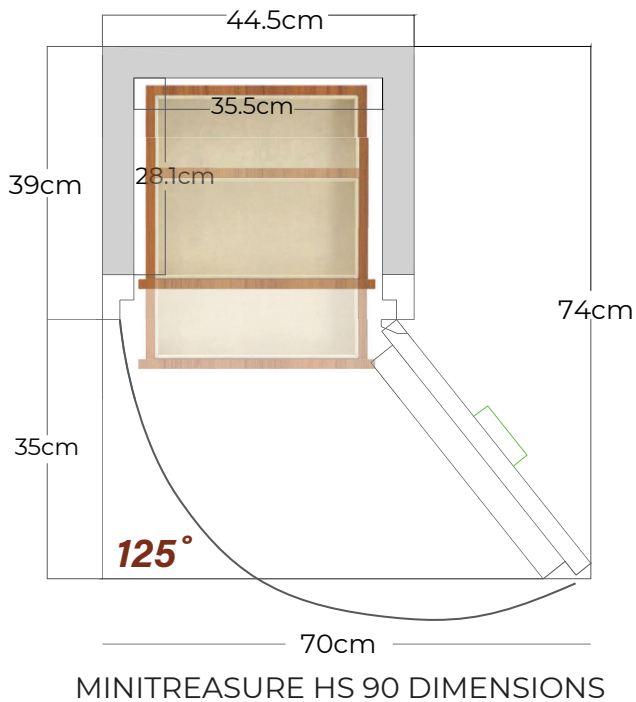

Safe Door Clearance

Our Minitreasure luxury safe is designed for seamless integration into wardrobes and cabinetry. For optimal functionality, ensure a **125-degree door opening** with the following clearance:

- **70 cm in front for unobstructed drawer movement**
- This opening angle allows to open the drawers fully.
- To ensure a hassle-free installation, we recommend our safe experts can make a site visit to discuss with your contractor or carpenter to determine the exact dimensions needed for your wardrobe construction.
- Or we are always happy to receive your contractor or carpenter to our showroom to see the safe physically and understand required space to open the drawers or access the safe fully.
- This guarantees a perfect fit and smooth operation once your safe arrives to your place.

Description	Minitreasure HS90	Minitreasure HS70	Minitreasure HS50	Minitreasure HS35
Height	100 cm	80 cm	60 cm	45 cm
Width	44.5 cm	44.5 cm	44.5 cm	44.5 cm
Depth	39 cm	39 cm	39 cm	39 cm
Weight	72 kg	61 kg	54 kg	41 kg
Number of drawers	10	8	6	4
Gun Drawers	Possible	Possible	Possible	Possible
Jewellery Drawers	Possible	Possible	Possible	Possible
Fire Resistance	30 mins	30 mins	30 mins	30 mins

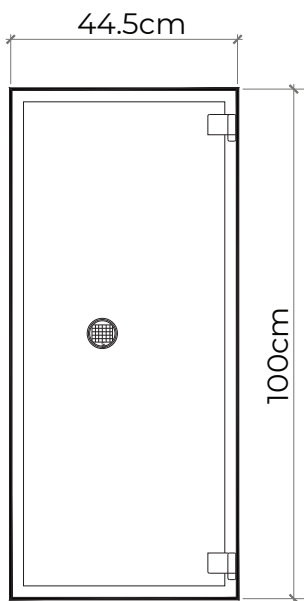

MINITREASURE HS90

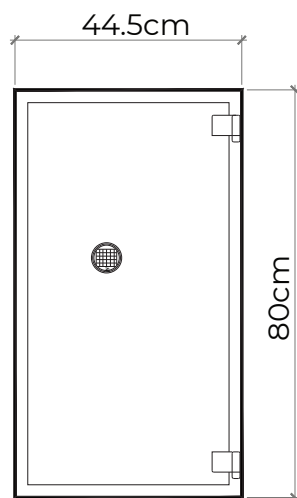

MINITREASURE HS70

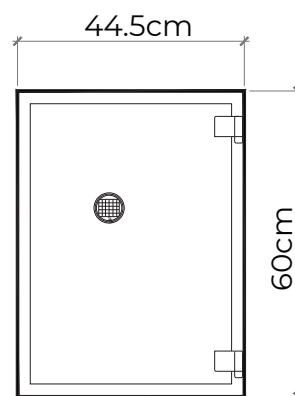

MINITREASURE HS50

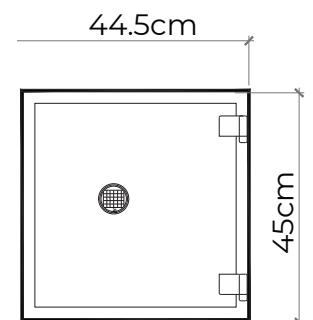

MINITREASURE HS35



KINDLY CONTACT US

+965 6695 5617 www.kaavalkuwait.com thomas@kaavalkuwait.com [@kaavalsecuritysystems](https://www.instagram.com/kaavalsecuritysystems)
[@chubbsafes_kuwait](https://www.instagram.com/chubbsafes_kuwait)

Al Rai, Kuwait, Hassan Abul Complex Block 4, Street 9, Near ACE Hardware,